

Lab Name:

Procedure #:

Procedure: CLIA Complexity: WAIVED

Prepared By	Date Adopted	Supersedes Procedure #

Review Date	Revision Date	Signature

Distributed to	# of Copies	Distributed to	# of Copies

This Procedural Bulletin is intended to provide a ready outline reference for performance of the assay. It is the obligation of every manufacturer of medical devices labeled *FOR IN VITRO DIAGNOSTIC USE* to provide a complete package insert in accordance with FDA labeling regulation (21 CFR 809.10). Prepared in accordance with the guidelines recommended by the Clinical and Laboratory Standards Institute, Wayne, PA 19087; CLSI Document GP2-A2.

Clarity Diagnostics provides CLSI procedures for your use. The procedures are required to include the same information as listed in the package insert. Any modifications to this document are the sole responsibility of the Laboratory.

Section 1 Introduction:

The Clarity Urocheck 120C Urine Analyzer reads urine test strips. It stores results and prints reports without the need for special training.

The Clarity Urocheck 120C Urine Analyzer runs a self-test each time the power switch is turned on. An optional barcode reader records patient ID. The barcode reader verifies strip canister barcodes. Use only **Clarity** Urinalysis Reagent Strips with the canister barcode for correct results.

The Clarity Urocheck 120C Urine Analyzer is CLIA waived when used with strips of the same brand as the analyzer. Only laboratories with a Certificate of CLIA Waiver may use this analyzer in a waived setting. Users should read this complete test procedure before performing a test using this analyzer. Failure to adhere to these instructions for use and for performing QC testing is considered off-label use. Off-label use is categorized as high complexity and subject to all CLIA regulations.

Intended Use:

The Clarity Urocheck 120C Urine Analyzer is intended for use in conjunction with the **Clarity** Urinalysis Reagent Strips for the semi-quantitative detection of Albumin and Creatinine. This instrument is intended for professional, *in vitro* diagnostic use only. These measurements are used to assist diagnosis of kidney functions. Positive results should be confirmed with quantitative method.

Clarity Liquid Urine Controls, CD-UCTL30 are assayed urine controls intended for use in validating the precision of the analyzer’s urinalysis readings for Creatinine and Albumin.

Caution: Federal law restricts this device to sale by or on the order of a physician or other practitioner licensed by the law of the State in which he practices, to use or order the use of the device.

Note: In this manual, keys on the keypad are listed in **bold**. Display items on the screen are listed in ***bold italics***.

Section 2 Analyzer Components:

Analyzer Component Illustrations

- | | |
|--------------------------|-----------------------------|
| 1 Keypad | 9 Strip Holder Stop |
| 2 Liquid Crystal Display | 10 White Calibration Circle |
| 3 Printer Cover | 11 Strip Holder Mount |
| 4 Printer Roller | 12 USB Port |
| 5 Printer Paper | 13 External Printer Port |
| 6 Printer | 14 Standard RS232C Port |
| 7 Strip Holder | 15 Power Socket |
| 8 Strip Holder Channel | 16 Power Switch |

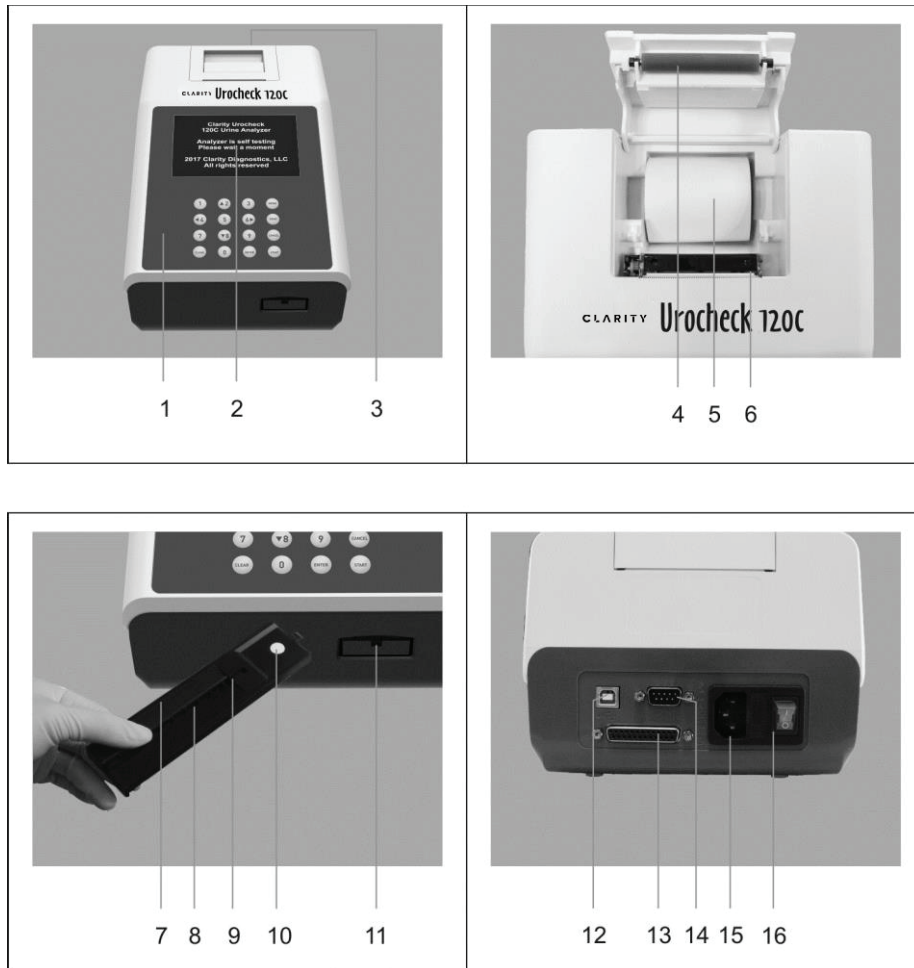

Section 3 Initial Startup:

Place the analyzer on a level surface. Allow 32" x 20" on all sides of the analyzer for access.

Plug the power cord into a power outlet. Press the power switch on the back panel to turn the Clarity Urocheck 120C Urine Analyzer on. The Clarity Urocheck 120C Urine Analyzer will run a Self-Test. The analyzer will display the screen shown below.

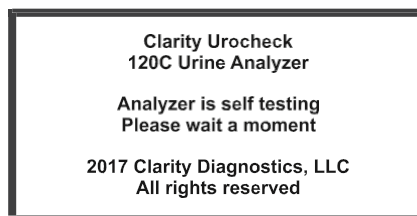

Turn the Power Switch on. If the Self-Test passes, the Initial Screen will be shown.



If the Self-Test fails, a **Failed** Screen will be displayed. The analyzer cannot be operated. Turn the power switch off then on to re-test. Refer to Section 10 Troubleshooting to correct the failure.

Press **MENU** to access the Test Settings, Analyzer Configuration, Database functions, Self-Test and QC Test.

Note: Use the arrow keys on the keypad to select **Exit** or press the **Cancel** key when **Exit** is not available.

Press **START** to begin strip testing. Press **ENTER** for **ID Admin** (ID Administration – where IDs can be assigned to different operators).

Section 4 Analyzer Setup:

Press **Menu** from the Initial Screen to display the screen below.

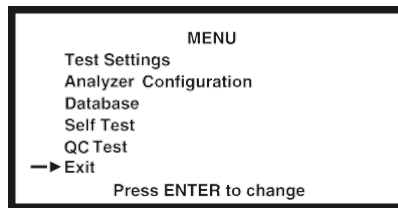

Select options by pressing **▲** or **▼** until the Selection Arrow (▣) is next to the option. Press **ENTER** to go to a new screen or cycle through the settings described below. Select **Exit** and press **ENTER** to return to the Initial Screen.

Test Settings

Select **Test Settings** to display the menu shown below.

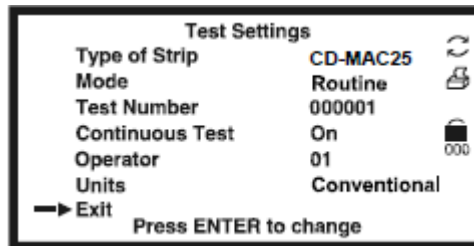

Press **▲** or **▼** to select an option. Press **Enter** to show or change the option settings below. Select **Exit** and press **Enter** to return to the **Main Menu**.

Type of Strips includes CD-MAC25. Refer to Appendix 2 for details.

Type of Strip	CD-MAC25
Mode	Routine, QC
Test Number	User selected number
Continuous Test	On, Off (single test) <i>(Function for moderate complexity labs only)</i>
Operator ID	If User Login is off, Operator ID will be 01 through 10. If User Login is on, Operator ID will be 11 through 20. 100 is reserved for the Administrator <i>(Function for moderate complexity labs only)</i>
Units	Conventional Units

Type of Strip

Select **Type of Strip** and press **ENTER** to change the strip type. The strip type defines the number of test parameters. Available strips are CD-MAC25 (microalbumin/creatinine). If **User Login** is enabled to control operator access, and **Operator ID** is 11 through 20, this setting cannot be changed. (*User Login Function for moderate complexity labs only*)

Refer to Appendix 2 for a detailed list of available parameters.

Note: Ensure the type of strip selected matches the strip to be used. If it does not, an error message will be displayed.

Mode

There are two test mode options. Press **ENTER** when **Mode** is selected to change the Mode.

Routine Test

Use for normal urine testing. The default test number ranges from 1 to 99999. If **Auto Number Reset** is set to **Yes** it will automatically reset to 1 every day.

QC Test

Use to test positive/negative controls. The test number ranges from 200001 to 299999. If **Auto Number Reset** is **Yes** it will automatically reset to 200001 every day.

Note: Ensure **QC Test** mode is used for testing positive and negative controls. Use of any other mode will report the testing results as a regular specimen and will not display proper "Pass/Fail" QC test results.

Test Number

Select **Test Number** and press **ENTER**.

Test Number

Old Number: 100012

New Number: 100012

Press ENTER to confirm
CANCEL to exit

Enter the new **Test Number**. Press **ENTER** to confirm. Press **CANCEL** to delete any changes and keep the existing number.

The first digit in the number will depend on the **Test Mode**. The first digit will be **0** for **Routine** and **2** for **QC Test**. This first digit is fixed and cannot be changed from this screen. Tests run after this number is changed will be set sequentially from the new number.

Note: Specimens may be assigned the same test number. They will be distinguished by test date and time in the Database.

Continuous Test -- (*Function for moderate complexity labs only*)

Select **Continuous Test** and press **ENTER** to cycle the settings to **Off** or **On**. When the selection is correct, select **EXIT** and press **ENTER** to return to the **Main Menu**.

Print Darkness	1 through 9
Printer Mode	Normal or Expand fonts
Auto-print	On or Off
Print Copies	1 to 3

Select **Exit** and press **ENTER** to save changes. The screen will then return to the previous **Menu**.

Select Printer

Internal prints the results on the internal printer.

External prints the results on an external printer. The symbol **EXT** will display on all screens. Contact your local distributor for a list of printers and printer cables that can be used.



Print Darkness

Print darkness ranges from **1 to 9**. The darkest is **9**. After **9** it reverts back to **1**. The default is **5**.

Printer Mode

Normal prints the standard font size and saves paper. **Expand** prints a larger font size and uses more paper.

Auto-print

Auto-print On prints the results after each test  is displayed. **Auto-print Off** requires pressing the **Print** key to print the results.  is not displayed.

Print Copies

Print Copies defines the number of result copies printed at one time. **Print Copies** can be set from 1 to 3.

Sound

Select **Sound** and press **ENTER** to cycle the options to **Off, On** and **Prompts**. These options function as listed below.

Off – internal speaker is **Off** in all cases. **On** – Internal speaker is **On** in all cases (keyboard and prompts).

Prompts – Internal speaker is **On** only for prompts to the operator. Select **Exit** with **→** and press **ENTER** to save changes. The screen will return to the **Main Menu**.

Barcode reader

Select **Barcode reader** and press **ENTER** to display **Yes** to allow Barcode reading. Press **ENTER** to cycle between **Yes** or **No**. **Yes** displays prompt for full usage of the Barcode reader. The **Barcode reader** icon  will be shown. If **Yes** is selected, plug in the barcode reader (as illustrated in the picture below) and the unit is ready for the operator to begin scanning barcodes. If the optional Barcode reader is not present, **Barcode reader** should be set to **No**. Select **Exit** with **→** and press **ENTER** to save changes. The screen will return to the **Main Menu**.



Language

(Default language is set to English)

Select **Language** (*This function is for moderate complexity CLIA designation labs only*) and press **ENTER** to change the current language. The language will change each time **ENTER** is pressed.

Select **Exit** with → and press **ENTER** to save changes. The screen will return to the Main Menu.

Date/Time

Select **Date/Time** and press **ENTER** to display the screen to change the date/time as shown below.

Select **Exit** and press **ENTER** to save changes. The screen will return to the previous **Menu**.

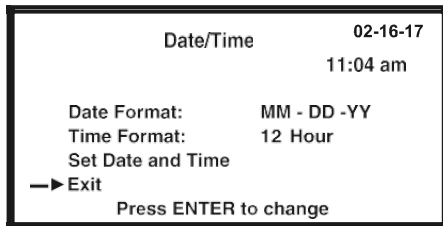

Press ▲ or ▼ to move → to the options listed below. Press **ENTER** to change the selected option.

Date Format

Select **Date Format** and press **ENTER** to cycle **MM-DD-YY**, **YY-MM-DD** or **DD-MM-YY**.

Time Format

Select **Time Format** and press **ENTER** to cycle to **24 Hour** or **12 Hour**. **12 Hour** displays the time with **am/pm** symbols.

Set Date and Time

Select **Set Date and Time** and press **ENTER** to set the current date and time.

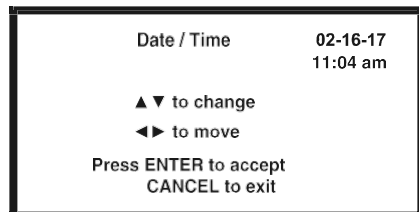

The first digit to be changed in the date will be highlighted. Press ▲ or ▼ to change the number one at a time. Continue to press ▲ or ▼ until the correct number is shown. Press ◀ or ▶ to progress to the next digit to be changed. Press ▲ or ▼ to increase or decrease the number. Change the time and date in this manner. Press **ENTER** to save the changes and exit the screen. Press **CANCEL** to discard all changes and exit. Either key will return to the previous screen.

Auto Number Reset

Select **Auto Number Reset** and press **Enter** to cycle to **Yes** or **No**. If **Yes**, the test number will reset to 000001 or 200001 for **Routine** or **QC** modes each day. If **No** the test number is unaffected by date.

Database

Select **Database** and press **ENTER** to display the screen below.

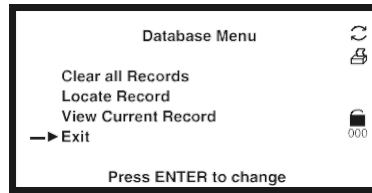

Press **▲** or **▼** to move **→** to enter each screen and make changes. After all changes are made press **ENTER** to save changes and return to the **Main Menu**.

Up to 2000 records can be stored in memory. If **User Login** is enabled and **Operator ID** is 11 through 20, the operator can only review data stored in the analyzer. *(The User Login function is for moderate complexity CLIA labs only.)*

Caution: Use a number higher than the previous test number.

If there are 2000 records stored in memory, the next test result will erase and replace the oldest record.

Records may have the same number but different dates and times.

Clear all Records *(The User Login function is for moderate complexity CLIA labs only.)*

Select **Clear all Records** and press **ENTER**. If **User Login** is enabled and **Operator ID** is 11 through 20, the analyzer will not respond.

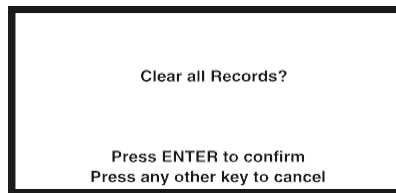

Press **ENTER** to delete all records. A prompt will appear. Once records are deleted they cannot be recovered. The **Test Number** will reset to 000001 or 200001 depending on the Test Mode. Press any other key to cancel. The screen will return to the **Database Menu**.

Locate Record

Select **Locate Record** and press **ENTER**.

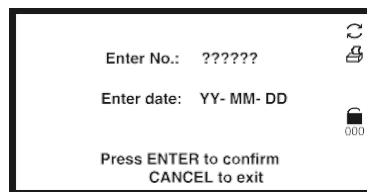

Press the number keys to enter the **Test Number** and/or test **Date**. Press **Enter** to view the results.

If only the **Test Number** is entered records with the current **Date** will be searched.

If there is no **Test Number** with the current **Date**, the latest previous **Date** will be searched. For example, assume the current date is 2017-03-27. There are two records with the same **Test Number** but dates of 2017-03-26 and 2017-03-20. The test from 2017-03-26 will be displayed.

If there is no record found **Record not found** will be displayed. Press any key to return to the **Database Menu**.

Press **Print** to print a record.

Press **▼** to view the previous record. Press **▲** to view the next record.

Press **CANCEL** to return to the previous screen. Additional records can be located, reviewed or printed.

View Current Record

Select **Current Record** and press **ENTER** to show the data from the current or last record.

Press **Print** to print a record once it is displayed.

Press **▼** to view the previous record. Press **▲** to view the next record.

Press **CANCEL** to return to the previous screen.

Self Test

Select **Self-Test** and press **ENTER** to perform self-tests. A results screen will display the results of each test.

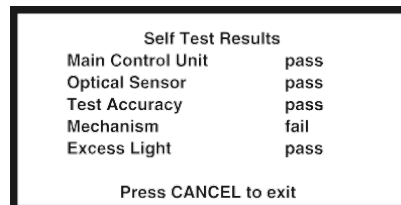

A **pass** or **fail** is displayed next to each test. If any results **fail**, the unit will not operate. Refer to Section 10 Troubleshooting.

Press **CANCEL** to return to the **Main Menu**.

QC Test

Select **QC Test** and press **ENTER**. If **User Login** is enabled and **Operator ID** is 11 through 20 the operator can only view settings and run a QC test. (*The User Login function is for moderate complexity CLIA labs only.*)

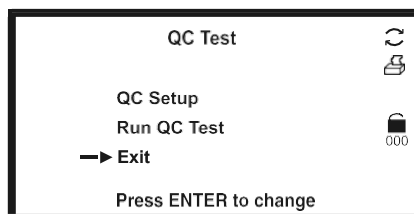

Press **▲** or **▼** to move **→** to make changes. Select **Exit** and press **ENTER** to save changes.

QC Setup

Each lab should set its own standards and procedures for performance. Test known controls (i.e., Clarity Liquid Urine Controls , CD-UCTL30) in case of any of the following events, following local, state, and/or federal requirements:

- A new canister of strips is opened
- A new operator uses the analyzer
- Test results seem wrong
- After performing maintenance or service on the analyzer

The QC test frequency is set to Daily by default.

Select **QC Setup** and press **Enter**.

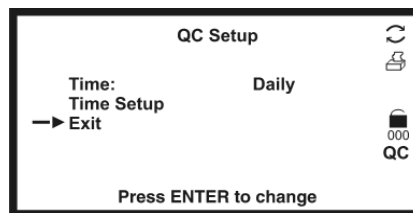

The **QC** symbol is displayed. QC Lockout timing can be set for **Every 8 Hours, Daily, Weekly or Monthly**.

Time

Select **Time** and press **ENTER** to set the QC test for **Every 8 Hours, Daily, Weekly or Monthly**.

Time Setup

Select **Time Setup** and press **ENTER**.

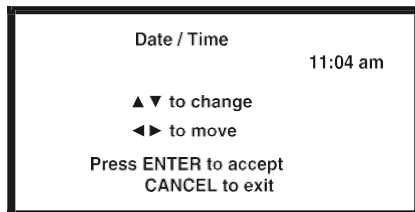

Every 8 Hours / Daily

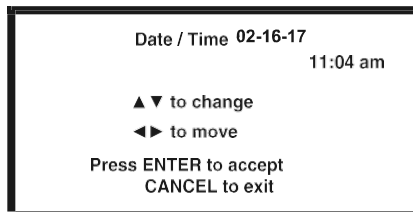

Weekly / Monthly

The first highlighted digit will be changed. Press **▲** or **▼** to change. Continue to press **▲** or **▼** until the correct number is shown. Press **◀** or **▶** to progress to the next digit to be changed. Press **▲** or **▼** to increase or decrease the number. Change each of the time and date digits/fields in this manner until the desired date is shown. Press **ENTER** to save the changes and exit the screen. Press **CANCEL** to discard changes and exit.

There is no **Date Setup** if QC tests are set for **Every 8 Hours** or **Daily**.

For the **Monthly** option, **Date** can be set from 01 to 28. 29, 30 and 31 are invalid.

Run QC Test

Select **Run QC Test** and press **ENTER** to perform a QC test before the next scheduled test time. When a QC test is run for the first time, please check the QC Values setup in the analyzer.

Setting the QC Values

QC values for Clarity Urine Liquid Controls (microalbumin and creatinine) are preset by Clarity at the factory.

User Login – (This function is for moderate complexity CLIA labs only)

Press **ENTER** from the Initial Screen to show the Administrator login screen. The Operator ID is preset to 100.

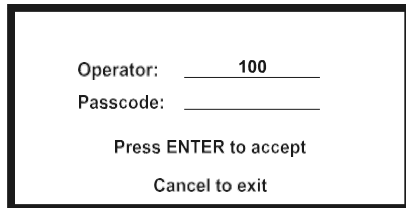

When viewing this screen for the first time, leave the **Passcode** blank and press **ENTER**.

Press **CANCEL** to return to the Initial Screen without enabling User Login.

ID Admin

The Administrator screen is shown.

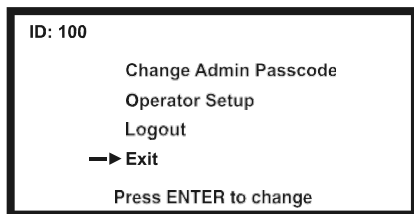

Press **▲** or **▼** to move the **→** to make changes. If Passcode is blank, user login is not yet enabled and only **Change Admin Passcode** can be chosen. Select **Exit** and press **ENTER** to save changes.

Change Admin Passcode

Change the passcode from blank to a valid passcode, select **Change Admin Passcode** and press **ENTER**.

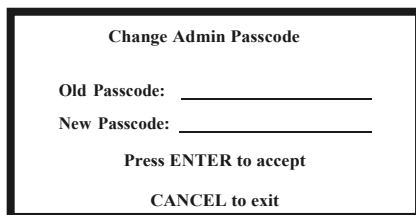

A non-blank passcode must be entered to enable **User Login**. If a blank is entered, a new screen will indicate the passcode is invalid. After 3 seconds, the screen will return to the login screen.

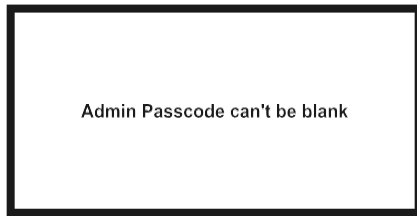

Press **CANCEL** to keep the existing passcode and exit.

Scan or enter a valid **Passcode** and press **ENTER** to accept and exit. **User Login** will be enabled.

Operator Setup

After **User Login** is enabled, select **Operator Setup** and press **ENTER**.

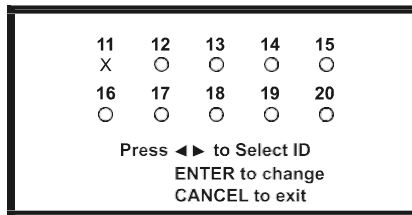

X indicates the ID is enabled. **O** indicates the ID is not enabled

Press ◀ or ▶ to move the cursor to the desired ID. Press **ENTER** for the **Passcode** screen.

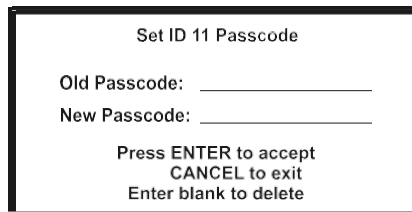

Scan or enter a new **Passcode**. Press **ENTER** to save the settings and exit. Press **CANCEL** to cancel the settings and exit. Enter a blank **Passcode** to disable the ID.

Logout

After the User Login is enabled, select **Logout** and press **ENTER** to log out. The normal Login screen will be shown for a new operator login. See Section 5 for Login procedures.

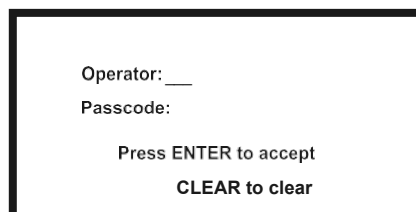

Press **CLEAR** from the Initial Screen to logout and display the Login Screen shown above.

Section 5 Analyzer Operation

If **User Login** is not enabled, the Initial Screen will be shown after Self-Test. Refer to Section 3 Initial Startup.

If **User login** is enabled (*This function is for moderate complexity CLIA labs only*), the analyzer will display a login screen after Self-Test.

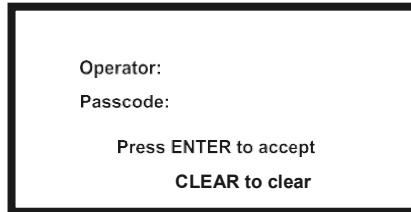

Enter the **ID** and enter or scan the **Passcode**. Press **ENTER** to run the analyzer. Press **CLEAR** to return to the login screen.

If the **Passcode** is incorrect, the analyzer will indicate a passcode error. After 3 seconds, the screen will return to the login screen.

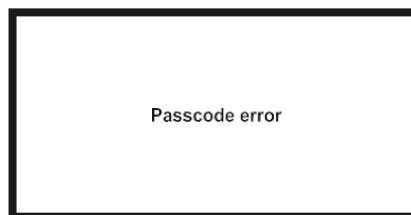

If the **Passcode** is correct, the analyzer will display the Initial Screen. The logged-in ID will be shown (11-20, or 100).

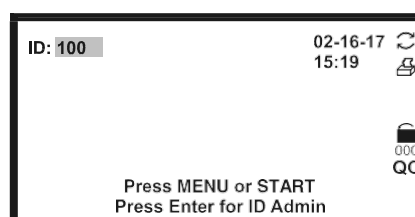
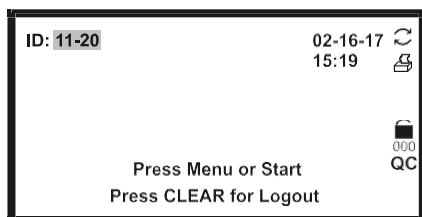





The user ID will be 11-20 for Operators. This provides access to operate the analyzer, change test modes and test number, and review settings. Press **CLEAR** from the Initial Screen to logout and display the Login Screen.

The user ID will be 100 for the Administrator. This provides full access to operate the analyzer and change settings. Press **ENTER** from the Initial Screen to display the ID Admin Screen.

Press **START** on the Initial Screen to test strips. Check all settings and strip types before testing.

During testing, the screens will display icons showing the status, options available and prompts for testing:

No. 000001	The sequential test number assigned to the next test to be run. In Routine Mode, the first digit will be 0 . In QC Mode, the first digit will be 2 .
CD-MAC25	Indicates the proper strip to be tested. Refer to Appendix 2. Select the strip configuration using the MENU function from the Initial Screen. The strip type must match the strip being used or result will not be displayed.
Mode	Indicates the current mode setting. Available modes are Routine and QC . Press ENTER from this screen to change the mode. Continue to press ENTER to cycle through each mode. The mode may be changed when this prompt appears.
	When visible, the analyzer is set to Continuous Test, testing up to 120 tests per hour. If not, the analyzer is set to Single Test, testing one strip at a time up to 60 tests per hour.
	When visible, the printer is set to Auto-print . Test data is sent to the internal printer and data ports after each test. Results are displayed on the screen. If this icon is not visible, press Print to send results to the printer and data port.
	When visible, Auto-Print is On . Test data is sent to the external printer and data ports after each test.
	When visible, indicates the Barcode reader is enabled.
EXT	If only EXT is visible, Auto-Print is Off . Press Print to send test data to the printer and data port.
	Strip Lockout is available. The analyzer will only test strips with correct barcodes.
QC	When the scheduled test time arrives, this symbol will flash. A beep will be heard to inform the user that a QC test is required before performing additional tests.

Entering Canister Code

When a new canister of strips is required, the analyzer will request a canister code from the new canister. The code can be entered manually from the keypad, or scanned with the Barcode reader, if installed.

At first startup, the Strip Holder will fully extend. The screen below will be displayed.

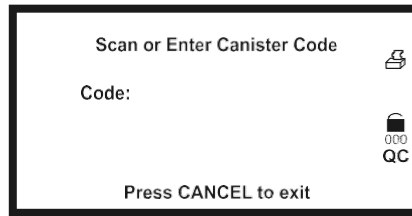

Scan or manually enter the canister code from the strip canister.

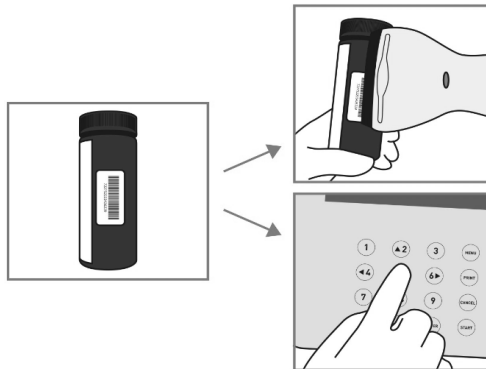

If you enter an incorrect number, press **CLEAR** to move the cursor to the proper digit. Edit the number as needed. After the last digit of the correct code is entered, the next screen will be shown. You can press **CANCEL** at any time to cancel changes and exit.

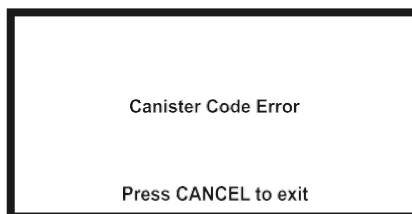

If the canister code is incorrect, the following screen will show.

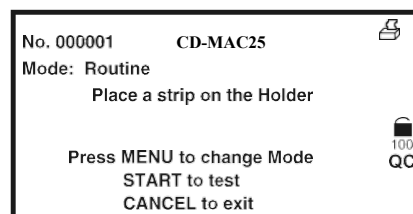

Press **CANCEL** to exit to the previous screen.

If the canister code is correct, the analyzer will proceed to the Initial Screen.



When there are only 5 strips remaining,  will flash to prompt that a new canister of strips is required. The number of strips left can be seen under .

When the current run is completed, enter the new canister code. The number under  will be

increased accordingly.

Note: Refer to the following for more information on the Strip Lockout function. Once a canister code is accepted, the analyzer will automatically recognize the Type of Strip and the number of strips per canister. The analyzer will keep track of the number of strips available for testing and the strips remaining will be displayed under the lock symbol. **Continue testing as usual until the analyzer prompts that a new canister code is required. When the analyzer prompts that a new canister code is required, scan or manually enter a canister code from a new canister to be used, or from the one currently in use.** The analyzer will not accept canister codes that have already been entered and will lockout the user until a new canister code is entered.

Normal Operation, no Barcode reader

Sample/Strip Preparation

Allow the strip, urine specimen, and/or controls to reach room temperature at 59-86°F (15-30°C) prior to testing.

Note: Only **Clarity** Urinalysis Reagent Strips work with the Clarity Urocheck 120C Urine Analyzer. Use of any other strips will result in “Strip Error” Message.

Remove the strips from the closed canister. Use them as soon as possible. Tightly close the canister after removing the strips.

Strip Test – Single Test Mode (This function is for CLIA-Waived settings)

START to show the testing screen. Once **START** is pressed, the screen below will show

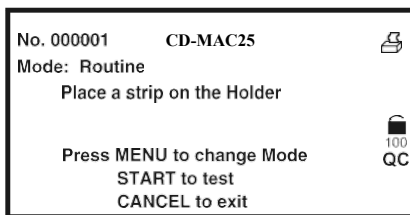

Dip the reagent strip into the fresh, well-mixed urine specimen, wetting all the pads. Immediately remove the strip from the urine to avoid dissolving the reagents. Run the edge of the strip against the side of the specimen container.

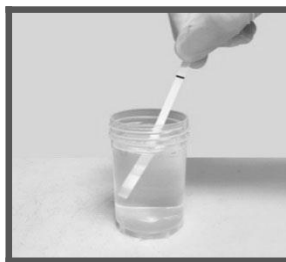

Blot by pressing the edge of the strip to an absorbent material (e.g. a paper towel) to remove the excess urine. This prevents mixing chemicals from adjacent reagent areas.

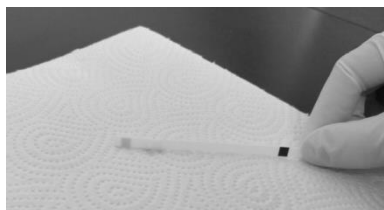

Place the strip on the strip holder with the reagent area facing up. Make sure the strip end touches the Strip Holder Backstop as shown below.



Press **START** again.

The countdown clock is displayed on the bottom right. The clock will start to count down from 65.

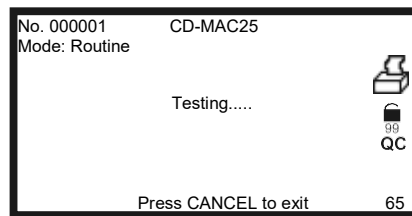

Note: When the countdown clock on the display reaches 1, the Strip Holder will carry the strip inside and begin testing. An automatic calibration is done before each test. The results will be displayed on the screen and stored in memory after each test. Any abnormal results will be highlighted on the screen and flagged on the print out. If **Auto-print** is set to **on** the results will be printed. If **Auto-print** is set to **off**, press **Print** to print the results.

Remove the used strip from the Strip Holder when the strip carrier moves out. Discard the used strip according to local regulations.

Repeat the previous steps to test more urine.

Strip Test – Continuous Test Mode

(This function is for moderate complexity CLIA designation labs only)

Press **START** to show the testing screen. Once **START** is pressed, the screen below will be shown.

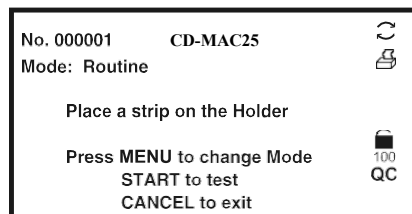

Dip the reagent strip into the fresh, well-mixed urine specimen, wetting all the pads. Immediately remove the strip from the urine to avoid dissolving the reagents. Run the edge of the strip against the side of the specimen container.



Blot by pressing the edge of the strip to an absorbent material (e.g. a paper towel) to remove the excess urine. This prevents mixing chemicals from adjacent reagent areas.

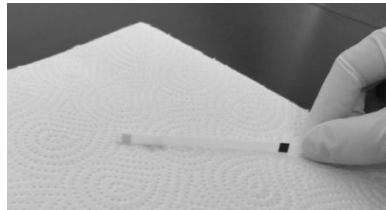

Place the strip on the strip holder with the reagent area facing up. Make sure the strip end touches the Strip Holder Backstop as shown below.



Press **START** again.

The countdown clock is displayed on the bottom right. The clock will start to count down from 65.

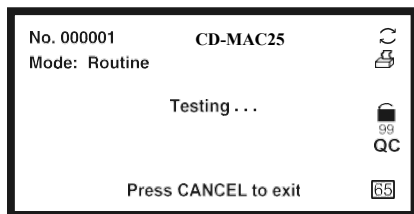

Place the first strip onto the Strip Holder Channel. Ensure the reagent pads face up. Make sure the end of the strip touches the Strip Holder Backstop.

Listen for the next triple beep and/or see the countdown clock reach **32**. Immerse a new second strip in fresh, well-mixed urine. Repeat the strip testing steps above. Lay the second urine-exposed strip on a paper towel, with reagent pads up. Wait for the first strip to complete testing and the Strip Holder to

move out.

Listen for the next triple beep and/or see the countdown clock reach **2**. Immerse a new third strip in fresh, well-mixed urine. Repeat the strip testing steps above. Lay the third strip on a paper towel with reagent pads up. Wait for the Strip Holder to move out.

Note: When the countdown clock reaches 1, the Strip Holder will carry the first strip inside. The countdown clock also returns to **30**. The results will be displayed on the screen for several seconds and stored in memory. If **Auto-print** is **on**, the results will be printed.

Remove the completed first strip after the Strip Holder moves out. Immediately place the second strip on the Strip Holder before the countdown clock reaches **1**. The Strip Holder will carry the new strip inside for analysis.

Note: The operator has about 8 seconds to discard the used strip and place the next strip on the Strip Holder.

After the first time the countdown clock reaches **1**, it will return to **30** instead of **65**. A triple beep occurs every 30 seconds. This prompts the operator to immerse a new strip.

Discard the used strip according to local regulations.

Repeat the above process for additional urine specimens.

Press **Cancel** to stop testing when all tests are done.

Normal Operation, Barcode reader installed

In the Barcode setup screen, if **Yes** is selected, plug in the barcode reader, as described below, and the unit is ready for the operator to begin scanning barcodes.

Plug the RS232C cable from the **Barcode reader** into the **Standard RS232C Port** in the back of the analyzer. Use the cable supplied with the **Barcode reader**. Refer to Appendix 5 **Barcode reader** for specifications and compatibilities.



If both the optional **Barcode reader** and external data transmission capability are used at the same time, use the serial splitter cable to connect both an external computer and **Barcode reader** to the analyzer **Standard RS232C port**.

Ensure the analyzer parameters are configured properly as described in **Section 4 Analyzer Setup**, with **Barcode Reader** set to **Yes**. Turn the power switch located at the back panel of the analyzer on.

Strip Test – Single Test Mode with Barcode reader

Press **START** from the Initial Screen.

The analyzer will prompt the user to scan the Barcode ID with the **Barcode reader**. If a Barcode reader is installed, hold the **Barcode reader** over the barcode on the specimen container and press the Scan button on the **Barcode reader**. A red illuminated line will appear over the barcode to be read. Move the **Barcode reader** to align the red line over the barcode. Position it until the **Barcode reader** beeps, indicating the barcode has been scanned. When the reading has been completed, it will appear next to **ID**. **ID** will reflect the last barcode read by the reader. It will change every time a new barcode is read until **START** is pressed to begin the test.

If a **Barcode reader** is not installed, enter the **ID** manually using the keypad. Press **CANCEL** to clear the input, **START** to begin the test.

Press **MENU** to change the current testing mode.

After the barcode is entered, **ID** will display. Review the ID before testing the strip.

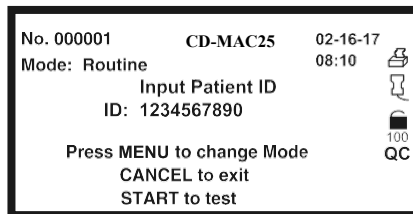

Press **START** after the **ID** has been entered to display the next screen.

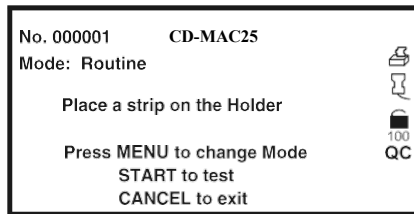

Press **START** again to begin strip testing. The strip is tested the same as other single test modes. The results screen will show the sample ID in the **ID** field.

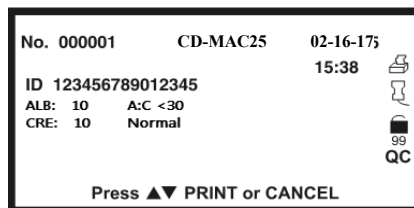

If **Auto-print** is **Off**, press **PRINT** from the results screen to print results. Press **CANCEL** to return to the previous barcode entry screen.

Strip Test – Continuous Test Mode with Barcode reader

(This function is for moderate complexity CLIA labs only)

If **Barcode reader** is **On** and  is displayed, samples are tested in batch mode. Holding the **Barcode reader** over the barcode on the specimen container, press the Scan button on the **Barcode**

reader. A red illuminated line will appear over the barcode to be read. Move the **Barcode reader** to align the red line over the barcode. When the **Barcode reader** beeps the barcode has been scanned. All sample barcode IDs in a batch are read and stored in memory in sequence. Samples must be run in the same sequence as scanned. This ensures IDs and samples match. Prompts are displayed to show the next sample to be tested.

Press **START** to begin the batch mode.

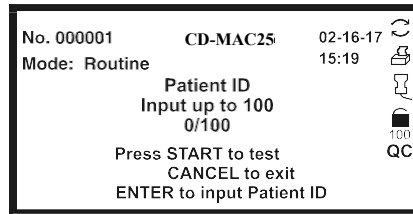

Press **CANCEL** to return to the *Initial screen*.

Press **ENTER** to enter a new screen to edit the Barcode ID.

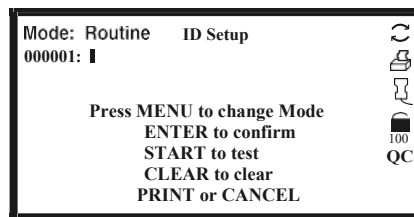

Use the keypad or barcode reader to enter the Barcode ID. Press **ENTER** to confirm the ID entered and enter the next number.

Press **CLEAR** to clear the entered ID. Press **PRINT** to print the list of IDs. **CANCEL** to exit to the previous screen.

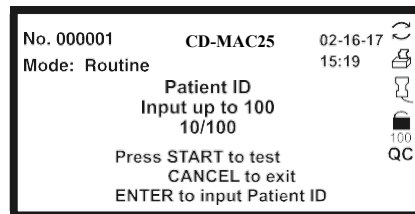

Press **START** to save the IDs and return to the previous screen.

Up to 100 barcodes can be read. The screen will indicate how many barcodes have been read.

Note: Do not change **Barcode reader** or **Test number** settings before all barcodes have been processed. Otherwise remaining barcodes may be deleted.

Press **START** to begin strip testing. The testing screen will be displayed as shown below. This example screen shows a total of 10 strips to be run. It asks for the first strip to be placed on the Strip Holder.

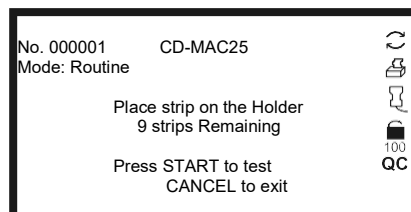

The next screen shows the barcode of the sample to be run and the next sample ID to be run. This reduces the possibility of error and mismatch between the barcode and the sample to be run.

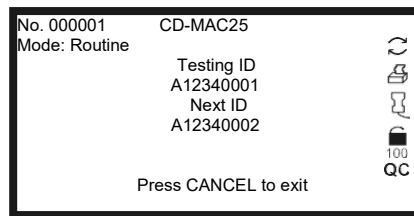

When the test is complete, the **Results Screen** will show briefly. The next strip can be placed on the Strip Holder.

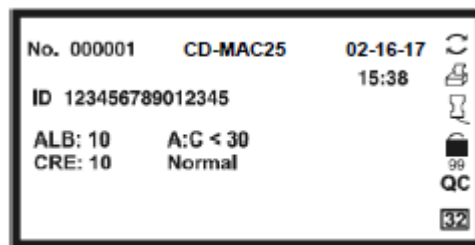

Stop testing by pressing **CANCEL** when the prompt appears. All other testing procedures are the same as testing with no barcode.

Urine Controls QC Testing

Ensure the operating **Mode** is set to **QC**. All test numbers in QC mode will begin with **2**. This allows results to be searched for and found easily.

Strip Preparation

Allow the strip and urine controls to reach room temperature at 59-86°F (15-30°C) prior to testing.

Note: Use **Clarity** Urinalysis Reagent Strips (Microalbumin/Creatinine) for proper functioning and accurate results.

Remove strips from the closed canister and use them as soon as possible. Close the canister tightly immediately after removing the strips.

Urine Control Test Procedures

The urine control test procedures are the same as “Normal Operation, no Barcode reader”, or “Normal Operation, Barcode reader installed”. Refer to **Section 5 Analyzer Operation**.

Results obtained during the Quality Control test will be referenced by the analyzer with pre-programmed target values and report generated, if **Auto-print** is set to **On**, the result will be printed.

If the QC fails, please contact Clarity Diagnostics technical support at 1-877-485-7877 for further assistance.

QC lockout

The user will be notified when a QC test is required. The following screen will be displayed. The **QC** symbol will flash.

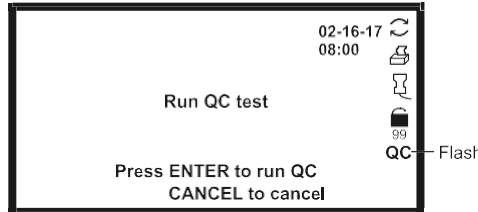

Note: Use *Clarity* Urinalysis Reagent Strips and urine controls for proper functioning and accurate results.

QC values for Clarity Urine Liquid Controls (microalbumin and creatinine) are preset by Clarity at the factory.

Press **CANCEL** to return to the Initial Screen.

Press **ENTER** to run QC tests.

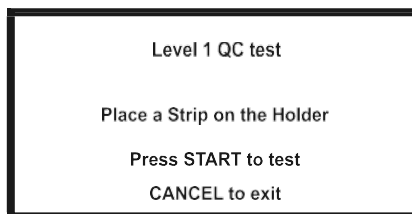

The analyzer will run a Level 1 QC test first. Refer to the **Strip Test** section for details on testing. After testing, the analyzer will display the testing results.

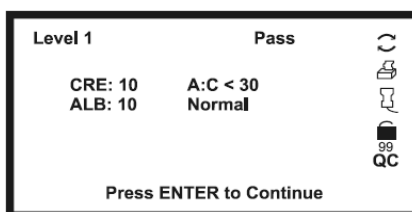

If any parameter is out of range, it will be highlighted and marked with a “*”.

If *Auto-print* is set to *On*, the result will be printed.

Press **ENTER** to test control Level 2. The steps are the same as for Level 1.

Date: 2017-02-16 16:54
 Operator: 11
 Level 1 Pass
 No. 200021
 CRE 10 mg/dL
 ALB 10 mg/L
 A:C <30 mg/g
 Normal

Date: ~~2017-02-16~~ 2017-02-16 16:54
 Operator: 11
 Level 2 Pass
 No. 200021
 *CRE 150 mg/dL
 *ALB 100 mg/L
 *A:C >30 mg/g
 Abnormal

If the QC test fails, the analyzer will be back to QC lockout screen:

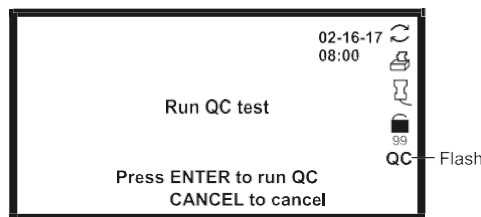

Section 6 Data/Communication

The RS232 and USB ports can communicate with an external (optional) PC.

If **Auto-print** is **On**, the printed data on the internal printer is also sent to the RS232 and USB ports. Connect either an RS232 or USB cable to the back of the analyzer to a PC with suitable software.

For Customer Service , call 1-877-485-7877 for further assistance

External Printer

The RS232 port can connect to an optional external printer for printing data.

For Customer Service , call 1-877-485-7877 for further assistance

Barcode Reader

The RS232 port can also connect to an optional Barcode reader. It can read and enter barcoded sample ID information.

For Customer Service , call 1-877-485-7877 for further assistance

Section 7 Quality Control

Quality control test is to validate the tests strip performance and urine analyzer operation. Errors resulting from user operation can also be detected in Quality Control test. Each lab should use its own standard and procedures for performance. Test known positive and negative specimens/controls in

case of the following events in accordance with local, state, and/or federal regulations or accreditation requirements.

- A new canister of strips is opened
- A new operator uses the analyzer
- Test results seem inaccurate
- After performing maintenance or service on the analyzer
- Whenever test results are in doubt

If QC tests do not provide expected results following errors may have occurred and perform recommended checks:

- Deterioration of the reagent strip areas due to exposure to light, ambient moisture or heat. Ensure strips are fresh from a new canister stored as per the instructions provided and repeat QC procedure.
Ensure if the strips used are not past their expiration date.
- Deterioration of the control solution. Ensure the controls are not past their expiration date.
- Repeat the test to ensure no errors were made during the test.

For Customer Service, call 1-877-485-7877 for further assistance

To run a quality control test:

- Wet each pad of a new urine strip with the controls.
- Blot off excess liquid. Place the strip on the strip holder.
- Press “START”.
- Compare QC results with the expected values. If the QC results do not match, do not test any patient samples until the problem is fixed. Repeat until the results are correct. See User Manual.

Section 8 Maintenance

Loading Printer Paper

Open the printer cover by pulling up on the tab.

Place the new paper roll into the printer paper compartment with the paper unrolling from underneath and towards the compartment wall.

Pull about 4 inches or 10 cm of paper past the top edge of the paper compartment

Note: Do not feed paper underneath the paper roller. Close the printer paper compartment by clicking the cover back into its original position. Press the printer cover after you close the cover to ensure that it is closed properly.



General Cleaning

Keep the surface of the instrument free of dust at all times. If needed, the external surfaces may be cleaned using a damp cloth. Do not use any type of solvent, oil, grease, silicone spray, or lubrication on any part of the instrument.

Remove the Strip Holder

Press **START** to fully extend the Strip Holder/Mount.

Turn off the Power Switch after the Strip Holder/Mount is fully extended.

Remove the Strip Holder from its mount by pulling out gently by the two sides as shown below.

Clean the Strip Holder

Clean the Strip Holder using a lint free/non-absorbent cotton swab/ball with distilled water if sediment is seen. Dry with a clean, dry cotton ball.

Examine the White Calibration Circle to ensure there are no nicks or dirt present. Clean the White Calibration Circle as necessary using a cotton swab or cotton ball with distilled water. Dry with a clean, dry cotton ball.

Note: The White Calibration Circle should be replaced if any nicks or non-removable dirt are found. For Customer Service, call 1-877-485-7877 for further assistance

Load the Strip Holder

Grasp the Strip Holder by its sides as shown below. Place the Strip Holder on the Strip Holder Mount with the white Calibration Circle facing up and positioned towards the analyzer. It will slide loosely in the locating channel. Push the Strip Holder in towards the analyzer until it snaps into place. It will be held firmly on the Strip Holder Mount. Ensure the Strip Holder is installed properly. If it is not locked onto the Strip Holder Mount, the Calibration Circle will not be in the correct position. The analyzer will display "Optical Sensor Failed."

Note: When correctly positioned, the Strip Holder will snap into and be locked in place, with the White Calibration Circle not visible. See illustration below.

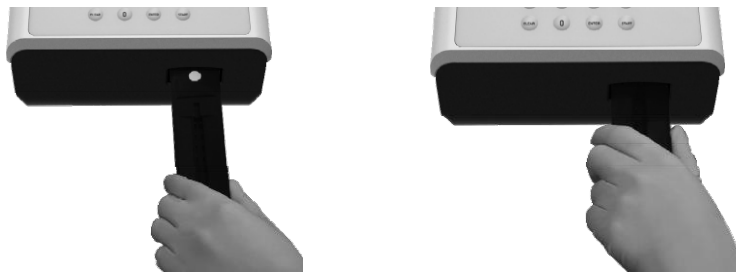

Return the Strip Holder/Mount to its Internal Position

Turn the Power Switch on and wait for the Strip Holder/Mount to move into the analyzer and stop. Turn the Power Switch off or begin testing strips.

Please refer to **Section 5 Analyzer Operation**.

Sample Holder Cleaning

Remove the Strip Holder and repeat Daily Cleaning above.

Clean the Strip Holder using a lint free non-absorbent cotton swab or ball with one of the following cleaning solutions:

1. 2% Glutaraldehyde (sufficient density): Refer to detailed instructions on the product label.
2. 0.05% Sodium Hypochlorite Solution: Add 1 mL 5% Sodium Hypochlorite into 99 mL distilled water, or prepare a 1:100 dilution ratio with appropriate final volume.
3. Isopropyl alcohol (70-80%).

Pour the cleaning solution into a narrow vessel 10 cm (4 inches) high.

Dip the Strip Holder into the cleaning solution

Caution: Ensure the White Calibration Circle does not touch the solution.

Soak the Strip Holder in the cleaning solution for 10 minutes.

Remove the Strip Holder, clean and dry it.

Load the Strip Holder and return the Strip Holder/Mount to its original position.

Section 9 Precautions

For accurate results, follow the precautions below when operating the analyzer.

- The protection provided by the equipment may be impaired if used in a manner not defined in this user guide.
- Connect to a power connection which contains a working grounding plug.
- Wear gloves to avoid contact with potentially hazardous biological samples during processing strips, or analyzer components.
- Avoid storing or operating the analyzer in direct sunlight, excessive temperature or humidity. Refer to **Appendix 1 Urine Analyzer Specifications** for operating condition requirements.
- Never place anything within 2.5" of the front of the unit. This will avoid interference with the Strip Holder.
- Keep the unit clean. Wipe it frequently with a soft, clean and dry cloth. Use fresh water when needed.
- Do not clean the unit with substances such as gasoline; paint thinner, benzene compounds or other organic solvents. This will avoid any damage to the Strip Holder, White Calibration Circle, or other components.
- Do not wash the LCD with water. Lightly wipe the LCD with a clean, soft and dry rag.
- The Strip Holder must be kept clean. Wipe the Strip Holder using fresh water daily. Refer to **Daily Cleaning** in **Section 8**.
- Follow all local regulations when discarding the unit or its accessories.
- Do not use the unit or the strips outside of the operating temperature ranges below.
Strips: 59-86°F (15-30°C)

Section 10 Troubleshooting

Problem	Solutions
Improper Strip Position	<ul style="list-style-type: none"> Adjust the strip so the strip end is completely touching the Strip Holder Backstop and centered in the Strip Holder Channel
Strip Missing	<ul style="list-style-type: none"> Insert strip
Strip Error	<ul style="list-style-type: none"> Make sure strip matches analyzer setting (see Type of Strip in Section 4) Make sure the brand of strip is compatible with the analyzer (i.e., Clarity Urinalysis Reagent Strip for microalbumin/creatinine). Make sure all of the test pads on the strip have been immersed in the specimen Ensure the test strip is not tilted or upside down
No display on screen	<ul style="list-style-type: none"> Turn the Power Switch on Make sure power is applied to the Analyzer
Printer does not work	<ul style="list-style-type: none"> Make sure Auto-Print is set to On. Refer to Printer Setup instructions Load paper if necessary. Ensure Printer Setup is set for Internal if an external printer is not connected Ensure paper roll is placed correctly. If incorrect, there will be no printout Clean printer roller with ethanol See that the proper side of the thermal paper is inserted in the printer
Main Control Unit Failed	<ul style="list-style-type: none"> Turn the Power Switch off, then on. Perform a Self-Test. Refer to Manual Self-Test section
Optical Sensor Failed	<ul style="list-style-type: none"> Ensure the Strip Holder is locked onto the Strip Holder Mount correctly. The Strip Holder should snap into place and locked onto the Strip Holder Mount. Ensure the white Calibration Circle is clean Clean the Strip Holder and refer to Daily Cleaning section Turn the Power Switch off, then on. Perform a Self-Test. Refer to Manual Self-Test section
Test Accuracy Failed	<ul style="list-style-type: none"> Turn the Power Switch off, then on. Perform a Self-Test. Refer to Manual Self-Test section
Mechanism Failed	<ul style="list-style-type: none"> Remove any obstacles in the path of the Strip Holder Do not touch the Strip Holder when it is moving Turn the Power Switch off, then on. Perform a Self-Test. Refer to Manual Self-Test section
Excess Light Failed	<ul style="list-style-type: none"> Ensure the Strip Holder is positioned correctly on the Strip Holder Mount. Refer to Daily Cleaning section Turn the Power Switch off, then on. Perform a Self-Test. Refer to Manual Self-Test section
Canister Code Error	<ul style="list-style-type: none"> Ensure the canister code entered is correct Ensure the type of strip used is the same as the analyzer setting.
QC Test Fail	<ul style="list-style-type: none"> Ensure the control is correct Ensure the type of strip is correct Ensure the brand of strip is compatible with the analyzer Ensure all of the reagent pads of the strip have been immersed
Internal Battery Failed	<ul style="list-style-type: none"> Stop testing and contact technical support at 1-(877)-485-7877

For Customer Service , call 1-877-485-7877 for further assistance. Hours of Operation: 8:00 am to 6:00 pm Eastern Standard Time (EST)

Appendix 1 Urine Analyzer Specifications

Feature	Specifications
Methodology	Reflectance Photometer
Detection	Photosensitive diode
Throughput	Single Test Mode: 60 tests/hour Continuous Test Mode: 120 tests/hour
Memory	Last 2000 results
Strip Incubation Time	1 minute
Detection Wavelengths	525 nm and 635 nm
Analyzer Ports	Standard RS232C Port for Barcode Reader or Data Transfer, USB Port for Data Transfer, 25 Pin Parallel Port for External Printer

Capabilities	Internal Thermal Printer (included), Optional External Printer (not included), RS232C Barcode Reader (optional), USB or RS232C Data Transfer Cable (optional)
Major Readable Barcodes	See Appendix 5
Available Languages on Screen	English (default in US and select countries) and all available languages
Analyzer Operating Conditions	32-104°F (0-40°C); ≤85% Relative Humidity (non-condensing)
Strip Operating Conditions	59-86°F (15-30°C); ≤85% Relative Humidity (non-condensing)
Power Source	100-240V AC, 50/60Hz, 35 VA
Weight	4.1 lbs. (1.85 Kg)
Dimensions (L X W X H)	10.8" X 7.2" X 5.5" (27.5 cm x 18.3 cm x 13.9 cm)
Display Dimensions (L X W)	4.2" X 2.6" (10.8 cm x 6.5 cm)

This product complies with EN 61326.

Appendix 2 URS Parameter Table

Parameter Name (Abbreviation on Display)	Arbitrary / Conventional	SI
Albumin (ALB)	10 mg/L	10 mg/L
	30 mg/L	30 mg/L
	80 mg/L	80 mg/L
	150 mg/L	150 mg/L
Creatinine (CRE)	10 mg/dL	0.9 mmol/L
	50 mg/dL	4.4 mmol/L
	100 mg/dL	8.8 mmol/L
	200 mg/dL	17.7 mmol/L
	300 mg/dL	26.5 mmol/L
A:C	<30 mg/g Normal 30-300 mg/g Abnormal >300 mg/g Abnormal	<3.4 mg/mmol Normal 3.4-33.9 mg/mmol Abnormal >33.9 mg/mmol High Abnormal

Appendix 3 Result Print-Out

The printed results are shown below.

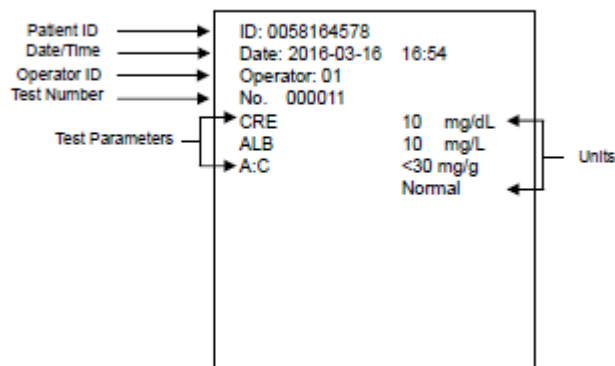

Depending on the type of strip selected, the analyzer recognizes the parameter order and automatically ranks the display and printing sequence of each parameter. Conventional results will always be printed automatically. Abnormal results, or results of pathological significance will be marked with an *.

All results will be reported with the respective data in front of the units.

Appendix 4 Barcode Reader

The **Clarity** Barcode reader is a laser barcode scanner. The Barcode reader connects to the analyzer to scan the patient (ID) barcode numbers on the specimen containers. The Barcode reader can scan the following:

• Code 39 (Standard/ Full ASCII)	• Codabar (NW-7)	• Code 128
• Italy Pharmacode	• UPCA	• EAN 128
• French Pharmacode	• UPCE	• MSI
• Industrial 25	• EAN8	• Plessey
• Interleave 25	• EAN13	• Telepen
• Matrix 25	• Code 93	• RSS

Note:

A maximum of 20 characters can be read by the barcode reader, and displayed, stored, and transmitted by the analyzer.























Warning: The Barcode reader is a Class 2 LED Product.

DO NOT stare into the beam.

Appendix 5 Catalog

Product Name	Catalog Number	Components	Quantity
Clarity Urocheck 120C Urine Analyzer	CLA-U120C	Clarity Urocheck 120C Urine Analyzer	1
		Printer Paper Rolls	2
		Power Cord	1
		Quick Start Guide	1
		Instruction Manual	1
Clarity Printer Paper Rolls	DTG-UAPPR	Thermal Paper	4
Clarity Sticker Paper Rolls	DTG- UASPPR	Sticker Paper	4
Clarity Urine Liquid Controls	CD-UCTL30	10 mL Level 1	3
		10 mL Level 2	3
		Product Insert	1

Appendix 6 Index of Symbols

	Consult accompanying documents		Manufacturer		Authorized Representative
	For <i>In vitro</i> diagnostic use only		Lot Number		Catalog #
	Store between 0-40°C		Tests per Kit		Serial Number
	Keep away from sunlight and heat		Use by	10101	Serial Port
	Keep Dry		Fragile, handle with care		This Side Up
	Continuous Test		Auto-print is on Internal printer is used	EXT	Auto-print is off External printer is used
	Auto-print is on External printer is used		USB Port		25 Pin Parallel External Printer Port
FUSE T2AL250VF	Fuses type		Power Socket		Grounding
QC	QC Lockout		Barcode reader		Strip Lockout

Appendix 7 Warranty

Please complete the warranty card included in the packaging. Mail it to **Clarity Diagnostics, LLC** to register your purchase within one year of purchase.

For your records, write the purchase date of your starter kit here:

Note: This warranty applies only to the analyzer in the original purchase. It does not apply to the other materials included with the analyzer.

Clarity Diagnostics, LLC warrants to the original purchaser that this analyzer will be free from defects in materials and workmanship for a period of one year (12 months). The one year starts from the later of the date of original purchase or installation (except as noted below). During the stated one year

period, **Clarity Diagnostics, LLC** shall replace the unit under warranty with a reconditioned unit or, at its option, repair at no charge a unit that is found to be defective. **Clarity Diagnostics, LLC** shall not be responsible for shipping charges incurred in the repair of such an analyzer.

This Warranty is subject to the following exceptions and limitations:

This warranty is limited to repair or replacement due to defects in parts or workmanship. Parts required which were not defective shall be replaced at additional cost. **Clarity Diagnostics, LLC** shall not be required to make any repairs or replace any parts that are necessitated by abuse, accidents, alteration, misuse, neglect, failure to operate the analyzer in accordance with the operations manual, or maintenance by anyone other than **Clarity Diagnostics, LLC**. Furthermore, **Clarity Diagnostics, LLC** assumes no liability from malfunction or damage to analyzers caused by the use of strips other than strips manufactured by **Clarity Diagnostics, LLC**. **Clarity Diagnostics, LLC** reserves the right to make changes in the design of this analyzer without obligation to incorporate such changes into previously manufactured analyzers.

Disclaimer of Warranties

This warranty is expressly made in lieu of any and all other warranties express or implied (either in fact or by operation of law) including the warranties of merchantability and fitness for use, which are expressly excluded, and is the only warranty given by **Clarity Diagnostics, LLC**.

Limitations of Liability

In no event shall **Clarity Diagnostics, LLC** be liable for indirect, special or consequential damages, even if **Clarity Diagnostics, LLC** has been advised of the possibility of such damages.

For warranty service, please call 1-(877)-485-7877.

Clarity Urocheck 120C Urine Analyzer Warranty Card

Please complete this warranty card and mail it to **Clarity Diagnostics, LLC** to register your purchase within one year of purchase. Refer to **Appendix 7 Warranty** in the Instruction Manual for details and terms of the product warranty.

Date of Purchase	Purchaser	Analyzer Serial Number (e.g. SN 0000000. See label on back of analyzer)
Organization Name		Address
Telephone Number		Email address
Purchased from/Distributor name:		



Clarity Diagnostics LLC.
1701 Green Rd, Suite A
Deerfield Beach, FL 33064
www.claritydiagnostics.com

QUALITY CONTROL LOG FOR CLARITY UROCHECK 10SG URINANALYSIS STRIPS

